

GD830F-24

Door Retaining Magnet

- Operating voltage 24Vdc
- Black powder-coat finish
- Up to 80lbs (36kg) holding force
- Fire tested - EN1155
- Over-ride switch
- Floor mount



FIRE
TESTED
- EN1155 -

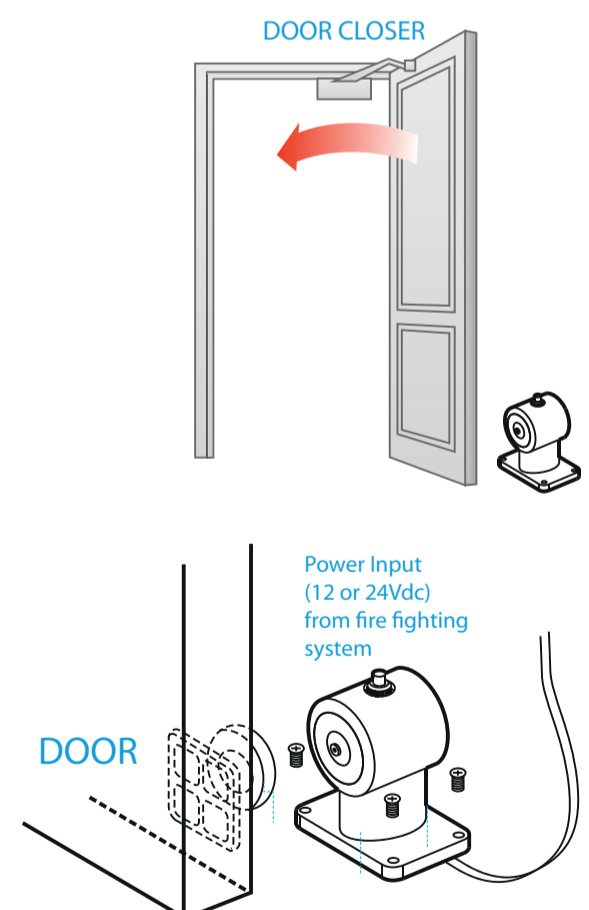
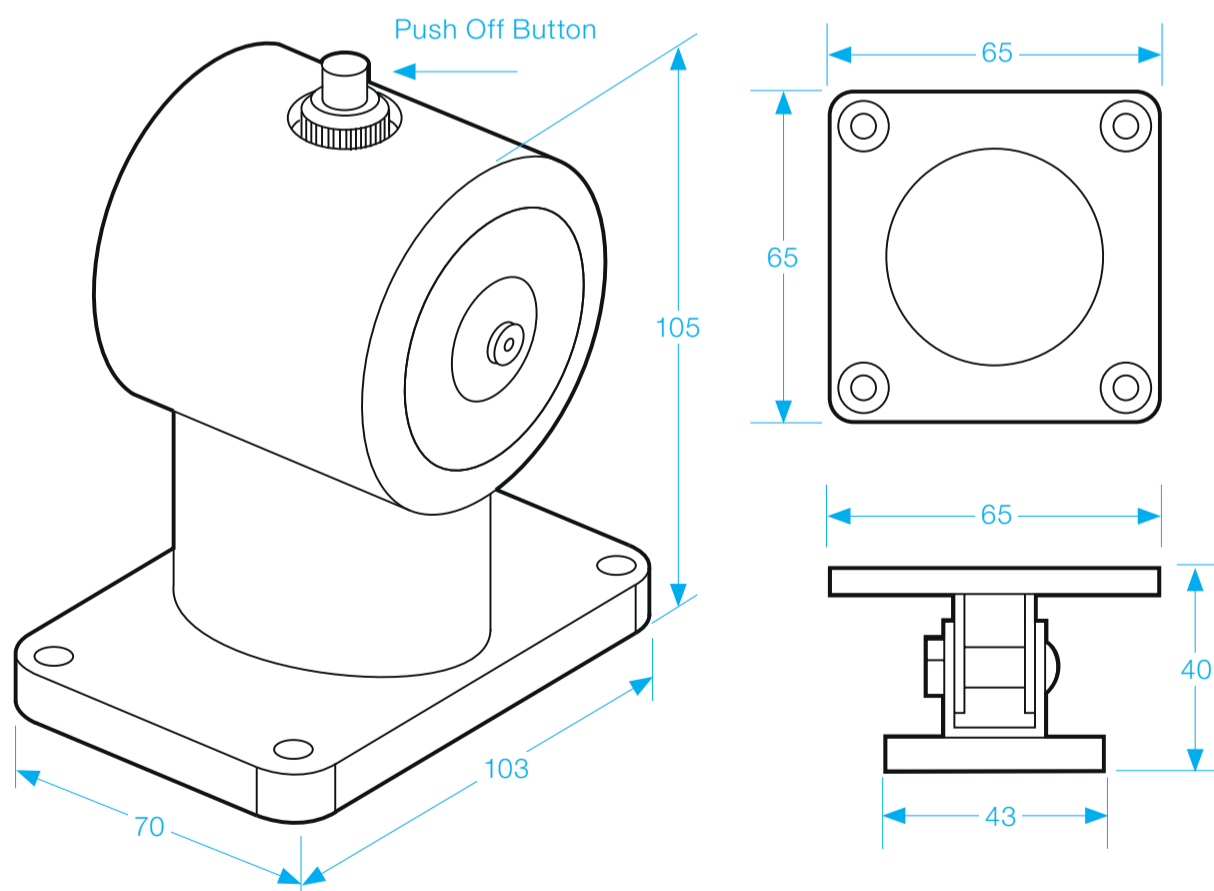

SPECIFICATION

- Voltage tolerance: $\pm 15\%$.
- Current draw: 130mA at 12Vdc, 60mA at 24Vdc (at temperature 20°C).
- Operating temperature: -10~45°C (14 to 131°F).
- Humidity: 0~95% non-condensing.
- Weight: 380g (approx).